

THIS DOCUMENT IS THE PROPERTY OF  
KEYSTONE ELECTRONICS CORP. AND  
SHALL NOT BE REPRODUCED, DISTRIBUTED  
OR USED AS A BASIS FOR MANUFACTURE  
WITHOUT PRIOR WRITTEN PERMISSION  
FROM KEYSTONE ELECTRONICS CORP.

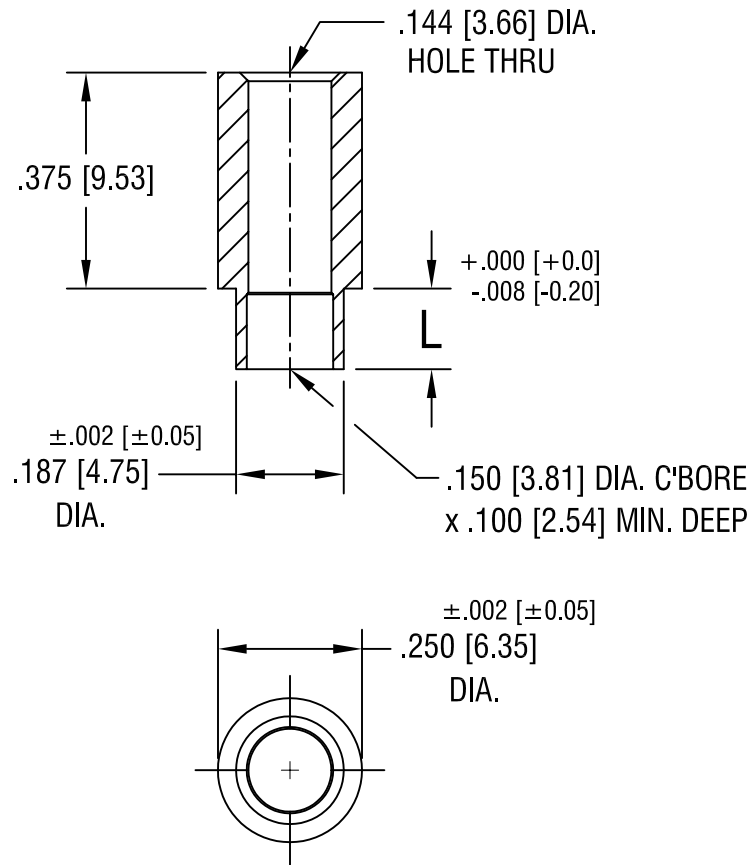

PART NO.	'L' DIM.
5064-2	.109 [2.77]
5064-3	.140 [3.56]

<b>KEYSTONE ELECTRONICS CORP.</b>			
ASTORIA, N.Y. 11105-2017			
PART NAME			
ROUND SWAGE CLEAR SPACER			
MATERIAL			
BRASS			
FINISH		DRN BY	DATE
DUCTILE NICKEL PLATE		BOONE	3.10.00
		APPD	SCALE
		LN	3X
TOLERANCES		INCH	[MM]
DECIMAL		±.005	[±0.15]
ANGULAR		± 1°	
UNLESS OTHERWISE SPECIFIED		CODE	DWG NO.
		C/M	<b>5064-</b>

DATE	DESCRIPTION	REV.